

Quick Reference

MDrive® 17 Motion Control with Industrial Connectors



Notes and Warnings

Installation, configuration and maintenance must be carried out by qualified technicians only.

- Unexpected dangers may be encountered when working with this product!
- Incorrect use may destroy this product and connected components!
- The drives are not protected from reverse polarity power connection!

Detailed information on installation can be found in the user manuals. The user manuals are available for download from:

<https://novantaims.com/downloads/>

Required for Setup*

- IBM compatible PC running Microsoft® Windows 7 or higher with available USB port.
- SEM Terminal integrated program editor and terminal emulator (available online).
- Monitor with a minimum of 1024 x 768 resolution.
- +12 to +48 VDC linear or switching power supply.
- RS-422/485 communications interface (e.g., MD-CC403-001 or MD-CC402-001 Communication Converters) or CANopen communications converter (e.g., MD-CC500-000).

Depending on the MDrive connectors configuration, the following may be required:

- I/O and Power interface to 19-pin M23 circular connector (e.g., MD-CS100-000 or MD-CS101-000 prototype development cordset).

* If the MDrive is purchased with a QuickStart Kit, all the connecting cables needed for initial functional setup and system testing are included.

Getting Started

All documentation, software and resources are available online at:

<https://novantaims.com/downloads/>.

Connecting Power and I/O

The MDrive can be configured with power and I/O combined on a single connector. Refer to "Motion Control Connectivity Options" on page 2 for connection details and available connectivity options, including Prototype Development Cables and Mating Connector Kits.

Connecting Communications — RS-422/485

1. Connect RS-422/485 communications converter to MDrive and PC.
2. Install the communication converter drivers onto PC (available online).
3. Install and open SEM Terminal.
4. Apply power to the MDrive.
5. Within SEM Terminal, click into the Terminal Window (shown below).
6. Key in CTRL+C. The MDrive sign-on message: "Copyright XXXX Schneider Electric Motion USA." should appear, verifying that communications is active.

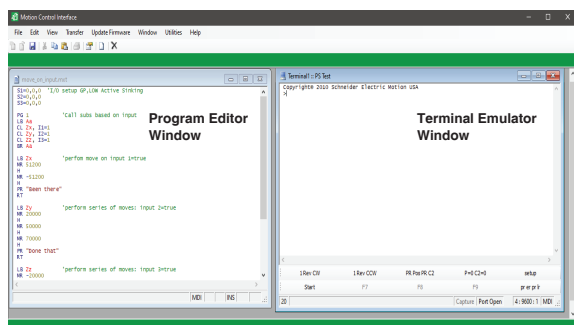

Connecting Communications — CANopen

A "Getting Started" tutorial using the CANopen Tester GUI with the MD-CC500-000 USB to CANopen dongle is located in the CANopen implementation manual, available online at:

<https://novantaims.com/downloads/>

General Specifications

Electrical Specifications

Input Voltage (+V) Range*	+12 to +48 VDC
Max Power Supply Current (Per MDrive 17)*	2 A
Aux-Logic Input Voltage**	+12 to +24 VDC
Aux-Logic Input Current**	194 mA Max

*Actual power supply current will depend on voltage and load.

**Used to power logic circuitry in the absence of +V.

Environmental Specifications

Operating Temperature (non-condensing)	Heat Sink	-40°C to +85°C
	Motor	-40°C to +100°C
IP-rated sealing		IP65

I/O Specifications

General Purpose I/O - Number and Type

I/O Points 1-4, 9-12	8 I/O programmable as inputs or outputs (sinking or sourcing)
----------------------	---

General Purpose I/O - Electrical

Inputs	TTL up to +24 VDC
Sinking Outputs	Up to +24 VDC
Sourcing Outputs	+12 to +24 VDC
Output Sink Current	up to 600 mA (One Channel in each I/O Bank)
Logic Threshold (Logic 0)	< 0.8 VDC
Logic Threshold (Logic 1)	> 2.2 VDC
Protection (Sinking)	Over Temp, Short Circuit
Protection (Sourcing)	Transient Over Voltage, Inductive Clamp

Analog Input

Resolution	10 Bit
Range (Voltage Mode)	0 to +5 VDC, 0 to +10 VDC
Range (Current Mode)	4 to 20 mA, 0 to 20mA

Clock I/O

Types	Step/Direction, Up/Down, Quadrature
Logic Threshold	+5V TTL Input, TTL Output (with 2 kΩ Load to Ground)

Trip Output/Capture Input

Logic Threshold	+5V TTL Input, TTL Output (with 2 kΩ Load to Ground)
-----------------	---

Communications Specifications

Protocol	RS-422/RS-485
BAUD Rate	4.8k, 9.6k, 19.2k, 38.4k, 115.2 kbps

CANopen Option

Protocol	CAN 2.0B Active
Communications Profile	CiA DS-301
BAUD Rate	10, 20, 50, 125, 250, 500, 800 kBits/s, 1MBit/s (default)
NOTE: 800 kbps not supported by the MD-CC500-000 USB to CANopen dongle.	

Motion Specifications

Microstep Resolution - Open Loop

Number of Resolutions	20
-----------------------	----

per step	Available Microsteps Per Revolution				
	1	2	4	5	8
per rev.	200	400	800	1000	1600
per step	10	16	25	32	50
per rev.	2000	3200	5000	6400	10000
per step	64	100	125	128	200
per rev.	12800	20000	25000	25600	40000
per step	250	256	180	108	127
per rev.	50000	51200	36000 ¹	21600 ²	25400 ³

¹ = 0.01 deg/μstep ² = 1 arc minute/μstep ³ = 0.001 mm/μstep

Software Specifications

Program Storage Type/Size	Flash/6384 Bytes
User Program Labels and Variables	192
Party Mode Addresses	62

Mechanical Specifications

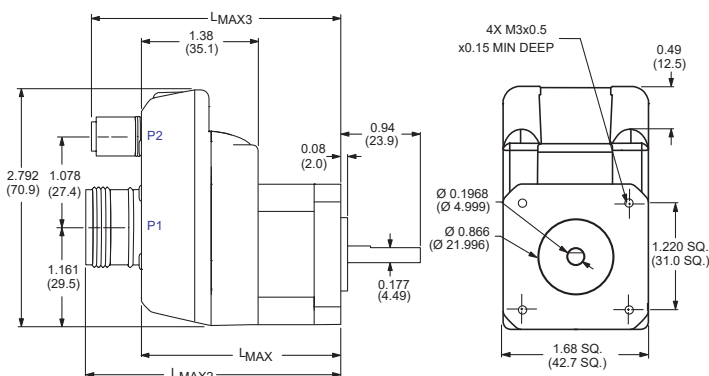

Motor Length	Dimensions in inches (mm)		
	LMAX	LMAX2	LMAX3
Single	2.48 (63.00)	3.15 (80.00)	3.08 (78.23)
Double	2.71 (68.83)	3.38 (85.85)	3.31 (84.10)
Triple	3.04 (77.22)	3.71 (94.23)	3.64 (92.46)

MDrive 17

Motion Control Connectivity Options

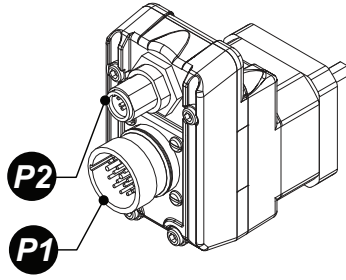

Connector Style

Function

P1	M23 industrial (male).....	I/O & Power
P2	M12 industrial (female).....	Communications
	M12 industrial (male).....	Communications (CANopen version)

P1 I/O and Power

19-pin M23 industrial connector (male)

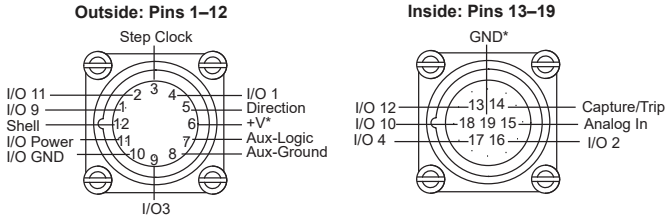

Prototype Development Cable

p/n (straight connector): MD-CS100-000
 p/n (right-angle connector): MD-CS101-000

Pre-wired mating connector interfaces to an MDrive 19-pin M23 circular connector, with flying leads other end, for quick test/development.

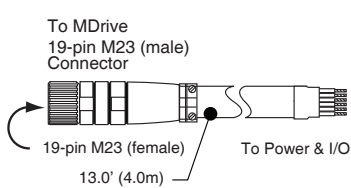

Wire Colors	Function	Encoder Function
Violet	I/O 9	Channel A+
Red	I/O 11	Channel B+
Gray	Step Clock	Index+
Red/Blue	I/O 1	I/O 1
Green	Direction	Index-
Blue	+V	+V
Gray/Pink	Aux-Logic	Aux-Logic
White/Green	Comm GND	Comm GND
White/Yellow	I/O 3	I/O 3
White/Gray	I/O GND	I/O GND
Black	I/O Power	I/O Power
Green/Yellow	Shell Connect	Shell Connect
Yellow/Brown	I/O 12	Channel B-
Brown/Green	Capture/Trip	Capture/Trip
White	Analog In	Analog In
Yellow	I/O 2	I/O 2
Pink	I/O 4	I/O 4
Gray/Brown	I/O 10	I/O 10
Brown	GND	GND

Mating Connector Recommendations

The MD-CS100-000 is recommended with 19-pin M23 connector.

For comparable connector only, shop vendors:

- Lumberg
- Phoenix
- Turck
- RDE Connectors

P2 Communications — RS-422/485

5-pin M12 industrial connector (female)

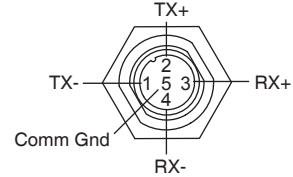

Communications Converter p/n: MD-CC401-001

Electrically isolated in-line USB to RS-422/485 converter pre-wired with mating connector to conveniently program and set configuration parameters.

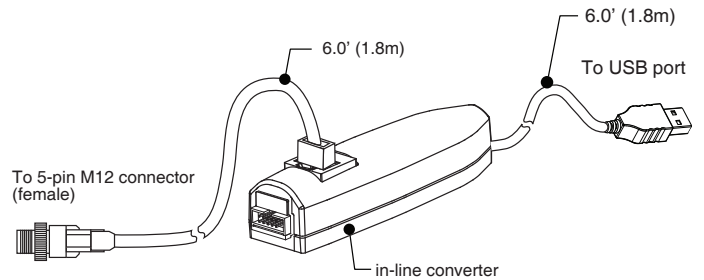

Mating Connector Recommendations

The MD-CC401-001 is recommended with 5-pin M12 connector.

For comparable connector only, shop vendors:

- Lumberg
- Phoenix
- Turck
- RDE Connectors

P2 Communications — CANopen version

M12 (male)

Communications Converter p/n: MD-CC500-000

Electrically isolated in-line USB to CANopen converter. USB "A" Type connector to DB-9 (male). An interface cable must be constructed by the user to interface to the MDrive.

Mating Cable Requirements

The following diagram illustrates the parts and connections for an interface cable connecting the MD-CC500-000 to the MDrive.

Parts Required	Connectors:	(1) DB-9 (female), (1) 5-pin M12 (female)
	Power Supply:	+7 to +30 VDC
	Terminating Resistor:	120 Ω 1%

