

Quick Reference

MDrive® 34 Motion Control with Flying Leads

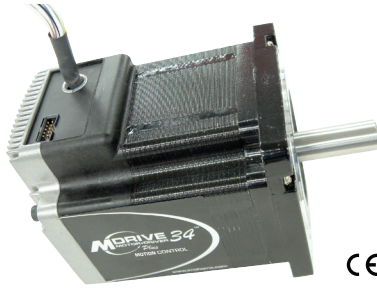

Notes and Warnings

Installation, configuration and maintenance must be carried out by qualified technicians only.

- Unexpected dangers may be encountered when working with this product!
- Incorrect use may destroy this product and connected components!
- The drives are not protected from reverse polarity power connection!

Detailed information on installation can be found in the user manuals. The user manuals are available for download from:

<https://novantaims.com/downloads/>

Required for Setup*

- IBM compatible PC running Microsoft® Windows 7 or higher with available USB port.
- SEM Terminal integrated program editor and terminal emulator (available online).
- Monitor with a minimum of 1024 x 768 resolution.
- +12 to +75 VDC linear or switching power supply.
- RS-422/485 communications interface (e.g., MD-CC400-001 or MD-CC402-001 Communication Converters). Or CANopen communications converter (e.g., MD-CC500-000).

Depending on the MDrive connectors configuration, the following may be required:

- A break-out board and cabling to interface to the 12" flying leads.

* If the MDrive is purchased with a QuickStart Kit, all the connecting cables needed for initial functional setup and system testing are included.

Getting Started

All documentation, software and resources are available online at: <https://novantaims.com/downloads/>.

Connecting Power and I/O

The MDrive is configured with Power and I/O on 12" flying leads. Refer to "Motion Control Connectivity Options" on page 2 for connecting details and available connectivity options, including Prototype Development Cables and Mating Connector Kits.

Connecting Communications — RS-422/485

1. Connect RS-422/485 communications converter to MDrive and PC.
2. Install the communication converter drivers onto PC (available online).
3. Install and open SEM Terminal.
4. Apply power to MDrive.
5. Within SEM Terminal, click into the Terminal Window (shown below).
6. Key in CTRL+C. The MDrive sign-on message: "Copyright XXXX Schneider Electric Motion USA." should appear, verifying that communications is active.

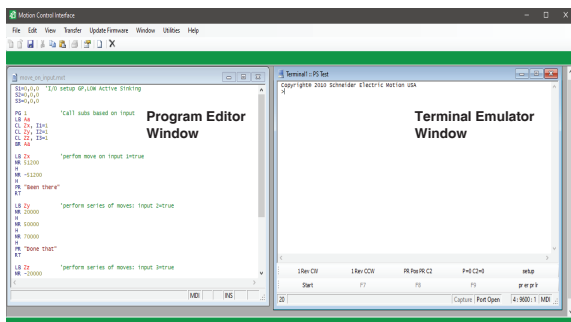

General Specifications

Electrical Specifications

Input Voltage (+V) Range*	+12 to +75 VDC
Max Power Supply Current (Per MDrive 34)*	4 A
Aux-Logic Input Voltage**	+12 to +24 VDC
Aux-Logic Input Current**	194 mA Max

*Actual Power Supply Current will depend on voltage and load.

**Used to power logic circuitry in the absence of +V.

Environmental Specifications

Operating Temperature (non-condensing)	Heat Sink	-40°C to +75°C
	Motor	-40°C to +90°C
IP-rated sealing		IP20

I/O Specifications

General Purpose I/O - Number and Type

I/O Points 1-4	4 I/O programmable as inputs (sinking or sourcing) or outputs (sinking)
----------------	---

General Purpose I/O - Electrical

Inputs	TTL up to +24 VDC
Sinking Outputs	Up to +24 VDC
Output Sink Current	up to 600 mA (one channel)
Logic Threshold (Logic 0)	< 0.8 VDC
Logic Threshold (Logic 1)	> 2.2 VDC
Protection (Sinking)	Over Temp, Short Circuit
Protection (Sourcing)	Transient Over Voltage, Inductive Clamp

Analog Input

Resolution	10 Bit
Range (Voltage Mode)	0 to +5 VDC, 0 to +10 VDC
Range (Current Mode)	4 to 20 mA, 0 to 20mA

Communications Specifications

Protocol	RS-422/RS-485
BAUD Rate	4.8k, 9.6k, 19.2k, 38.4k, 115.2 kbps

Motion Specifications

Microstep Resolution - Open Loop

Number of Resolutions	20
-----------------------	----

per step	Available Microsteps Per Revolution				
	1	2	4	5	8
per rev.	200	400	800	1000	1600
per step	10	16	25	32	50
per rev.	2000	3200	5000	6400	10000
per step	64	100	125	128	200
per rev.	12800	20000	25000	25600	40000
per step	250	256	180	108	127
per rev.	50000	51200	36000 ¹	21600 ²	25400 ³

1=0.01 deg/μstep 2=1 arc minute/μstep 3=0.001 mm/μstep

Software Specifications

Program Storage Type/Size	Flash/6384 Bytes
User Program Labels and Variables	192
Party Mode Addresses	62

Mechanical Specifications

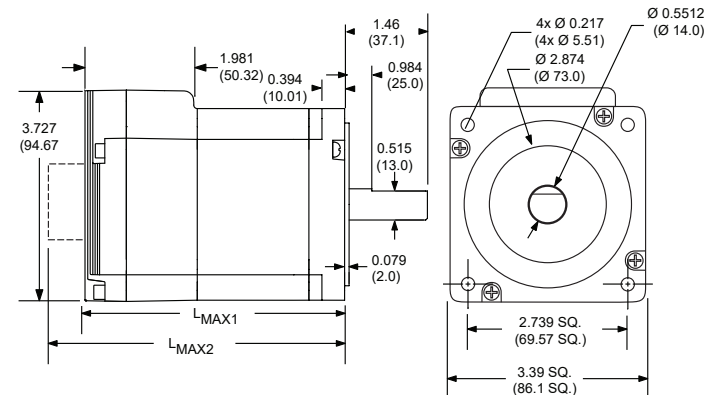

Motor Length	Dimensions in inches (mm)	
	LMAX1 (Single Shaft)	LMAX2 (Control Knob)
Single	3.81 (96.77)	4.52 (114.81)
Double	4.60 (116.84)	5.31 (134.87)
Triple	6.17 (156.72)	6.88 (174.75)

MDrive 34

Motion Control Connectivity Options

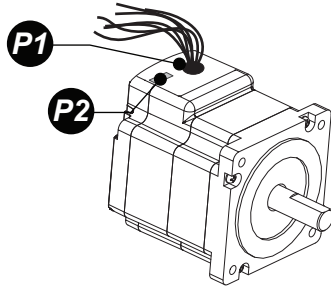

Connector Style	Function
P1 Flying Leads.....	I/O and Power
P2 10-pin IDC.....	Communications
10-pin Wire Crimp.....	Communications

P1 I/O & Power Flying leads

Wire Color	Function
White/Yellow	I/O 1
White/Orange	I/O 2
White/Violet	I/O 3
White/Blue	I/O 4
Green	Analog In
Black	Ground
Red	+V

P2 Communications — RS-422/485 10-pin IDC

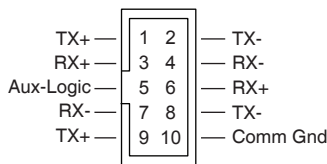

Communications Converter p/n: MD-CC400-001

Electrically isolated in-line USB to RS-422/485 converter pre-wired with mating connector to conveniently program and set configuration parameters.

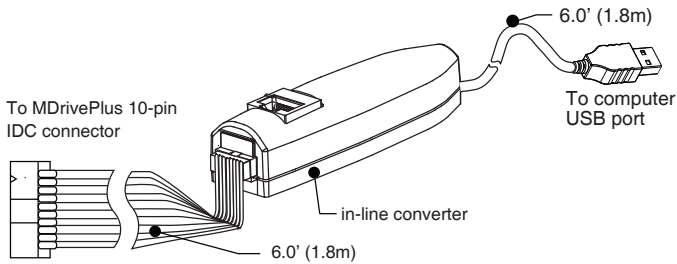

Mating Connector Kit p/n: CK-01

Use to make cables, kit contains 5 mating connector shells with crimp pins.

IDC Parts	Shell:	SAMTEC TCSD-05-01-N
	Ribbon Cable:	TYCO 1-57051-9

P2 Communications — RS-422/485 10-pin wire crimp

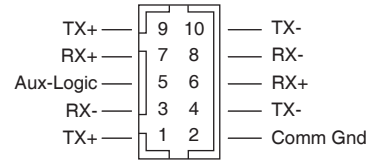

Communications Converter p/n: MD-CC402-001

Electrically isolated in-line USB to RS-422/485 converter pre-wired with mating connector to conveniently program and set configuration parameters.

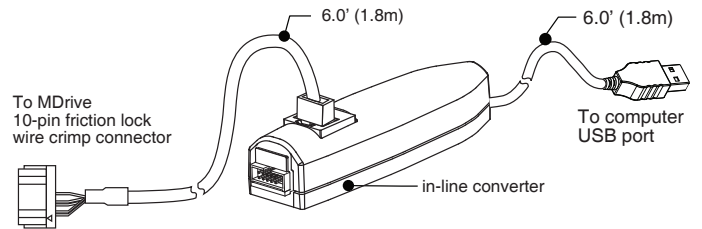

Prototype Development Cable p/n: PD10-1434-FL3

Speed test and development with pre-wired mating connector. Recommended for multi-drop systems, can be used in conjunction with the MD-CC402-001.

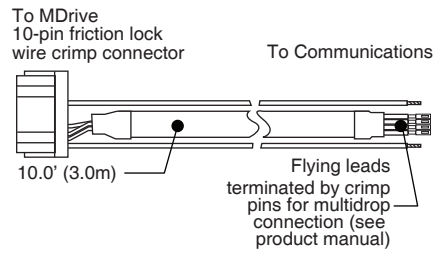

Wire Colors	Function
White/Red Stripe	Aux-Logic
White/Blue Stripe	TX+
Blue/White Stripe	TX-
White/Orange Stripe	RX+
Orange/White Stripe	RX-
Green/White Stripe	GND

Mating Connector Kit p/n: CK-02

Use to make cables, kit contains 5 mating connector shells with crimp pins. Hirose crimp tool recommended.

Hirose Parts	Shell:	DF11-10DS-2C
	Pins:	DF11-2428SC